



Pictures	Specification	Shaft Length (mm)	Color
	QMBE-I	60	White
	QMBE-II	160	
	QMBE-III	260	White+Blue

# Disposable Endoscopic Stapler and Reloads



Pictures	Specification	Staple Height (mm)	Suturing Length (mm)	Staple Quantity (pcs)	Color
Straight	QMBEC-30C	2.5	31	42	White
	QMBEC-45C	2.5			White
	QMBEC-45B	3.8			Purple
	QMBEC-45P	4.0	46	66	Gold
	QMBEC-45A	4.8			Black
	QMBEC-45S	2.4/2.6/3.0			White
	QMBEC-45E	3.4/3.6/4.0			Purple
	QMBEC-45F	4.4/4.6/4.8			Black
	QMBEC-60C	2.5			61
	QMBEC-60B	3.8	Purple		
	QMBEC-60P	4.0	Gold		
	QMBEC-60A	4.8	Black		
	QMBEC-60S	2.4/2.6/3.0	White		
	QMBEC-60E	3.4/3.6/4.0	Purple		
	QMBEC-60F	4.4/4.6/4.8	Black		
Articulating	QMBEL-30C	2.5	31	42	White
	QMBEL-45C	2.5			White
	QMBEL-45B	3.8			Purple
	QMBEL-45P	4.0	46	66	Gold
	QMBEL-45A	4.8			Black
	QMBEL-45S	2.4/2.6/3.0			White
	QMBEL-45E	3.4/3.6/4.0			Purple
	QMBEL-45F	4.4/4.6/4.8			Black
	QMBEL-60C	2.5			61
	QMBEL-60B	3.8	Purple		
	QMBEL-60P	4.0	Gold		
	QMBEL-60A	4.8	Black		
	QMBEL-60S	2.4/2.6/3.0	White		
	QMBEL-60E	3.4/3.6/4.0	Purple		
	QMBEL-60F	4.4/4.6/4.8	Black		



**Jiangsu Qianjing Medical Equipment Co.,Ltd**

Add: No.6 Fengming Road, Wujin Hi-tech Industrial Development Zone, Wujin District, Changzhou, Jiangsu, China

Mail: sales@qjmed.com

Web: www.qjmed.com



## DISPOSABLE ENDOSCOPIC STAPLER AND RELOADS

### Application

It is suitable for resection, transection and anastomosis of lung, bronchial tissue, stomach and intestinal in open or endoscopic surgery. Be applicable in thoracic surgery, abdominal surgery and gynecologic endoscopy.

### Features and Advantages

- Better blood supply, better tissue thickness adaptability, less tissue crush injury.
- The design of six rows cross staplers, keep tissue safe.
- Single use blade, changed with reload. Ensure the blade is sharp and reduces tissue damage.
- Equipped with the safety inter lock device to prevent the used reload from being triggered again, thus ensured safety in surgical operation.
- Isometric height retainer structure, made the staple mold consistently.
- Different altitude for staple, the ladder nail bin is suitable for pressing various tissue thickness, effectively clamping and firing.



The rotary knob rotates smoothly, steadily and convenient to reach the tissue.



360° rotation and left right 45° swing could one-time envision different tissue.



Wide front opening of reload is convenient for operation.



The "Gecko Claw" surface convex design reduces the lateral and longitudinal oscillation of the staple and keeps the tissue stable and does not slide during the firing process.

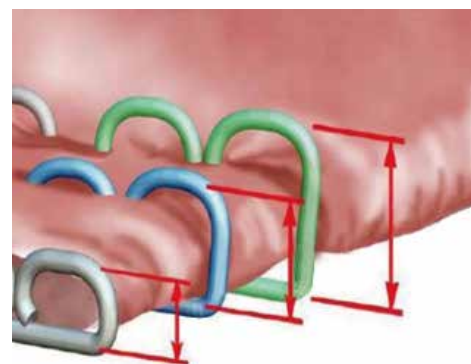

Advanced unequal nail design - perfect cutting and suturing ensure excellent blood supply to the anastomosis, greatly improving the recovery rate after surgery.

## DISPOSABLE ENDOSCOPIC STAPLER AND RELOADS

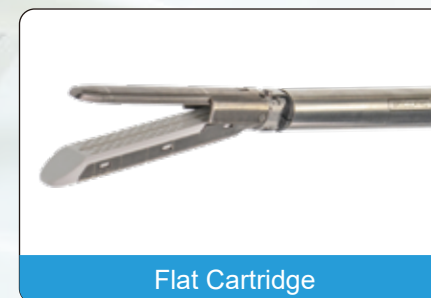

Flat Cartridge

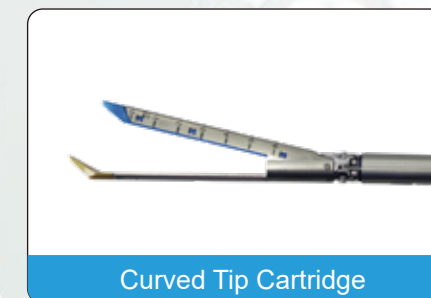

Curved Tip Cartridge



Unequal nail Cartridge with Gecko paw design

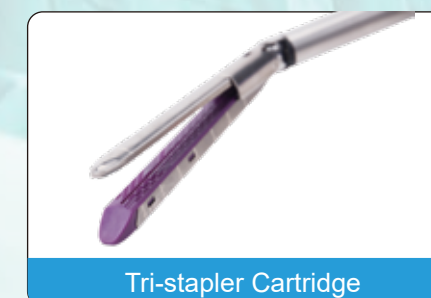

Tri-stapler Cartridge

# Disposable Endoscopic Stapler and Reloads



QIAN JING

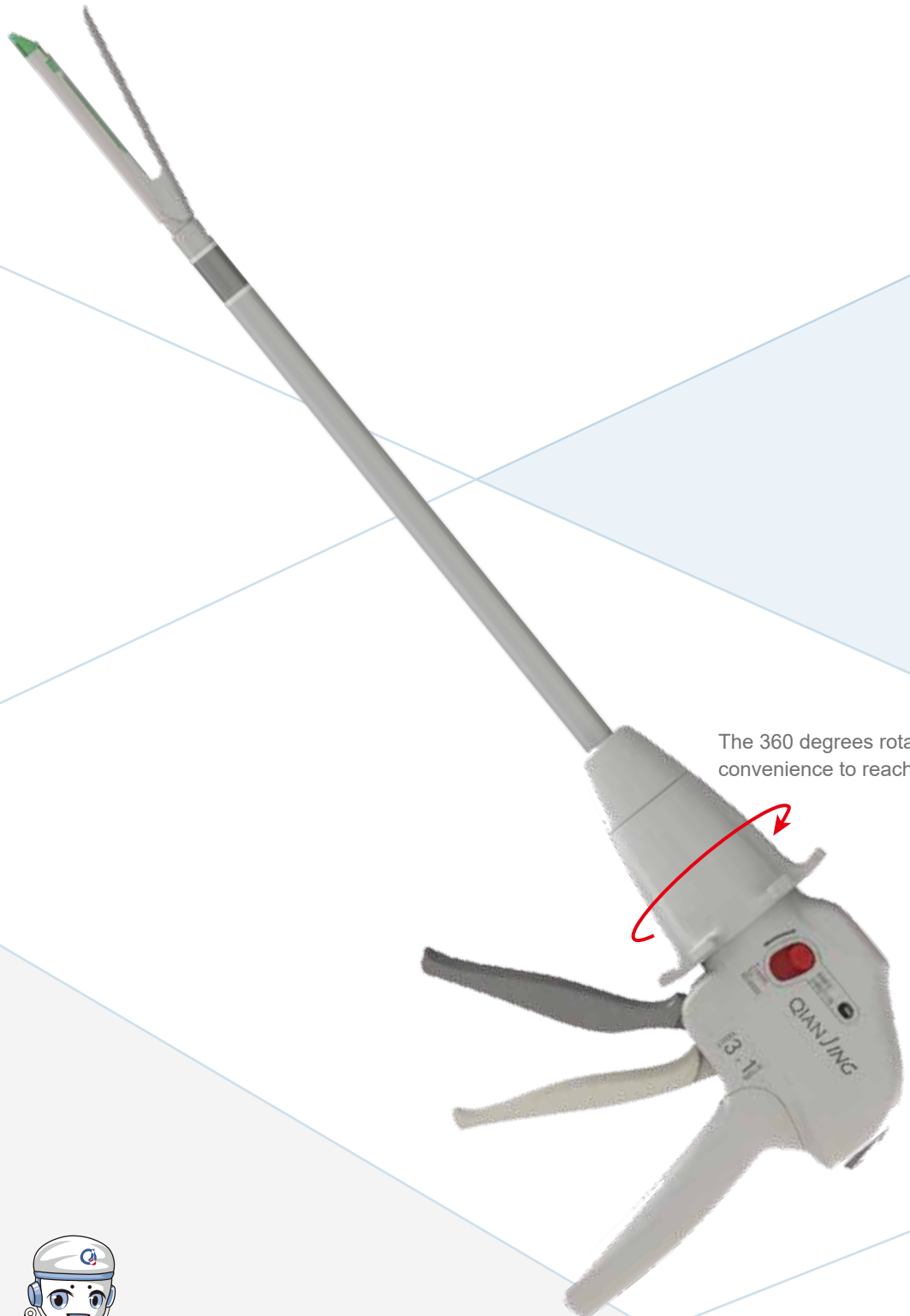

The 360 degrees rotary ensures convenience to reach tissue.



# DISPOSABLE ENDOSCOPIC STAPLER AND RELOADS

## Application

It is suitable for resection, transection and anastomosis of lung, bronchial tissue, stomach and intestinal in open or endoscopic surgery. Be applicable in thoracic surgery, abdominal surgery and gynecologic endoscopy.

## Features and Advantages

- One-handed control ensures complete tissue cutting and reduces tissue damage.
- Better tissue thickness adaptability.
- Larger rotation angle for easier operation.



The adaptive joint head design can swing around 90°. The adaptive joint head adjustment method is flexible and can realize one-hand operation and facilitate surgical operation.



The manual knife return button makes the operation safer.



The blade direction indicator window clearly indicates the direction in which the blade travels to ensure safe operation without accident.

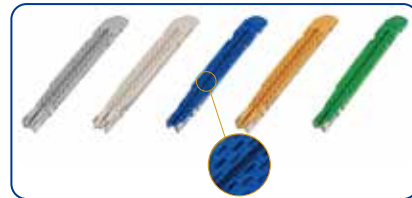

Stepped nail design, white, blue, gold, green four nail cartridges, respectively, for different thickness of tissue.

Product Name	Pictures	Specification	Shaft Length (mm)
Disposable Endoscopic Stapler		QSAE-45A	265
		QSAE-45B	325
		QSAE-45C	425
		QSAE-60A	280
		QSAE-60B	350
		QSAE-60C	440

Specification	Staple Height (mm)	Suturing Length (mm)	Staple Quantity (pcs)	Color
QSAEL-45B	2.5	46	66	White
QSAEL-45C	3.5			Bule
QSAEL-45D	3.8			Gold
QSAEL-45E	4.1			Green
QSAEL-60B	2.5	61	88	White
QSAEL-60C	3.5			Blue
QSAEL-60D	3.8			Gold
QSAEL-60E	4.0			Green

## Jiangsu Qianjing Medical Equipment Co.,Ltd

Add: No.6 Fengming Road, Wujin Hi-tech Industrial Development Zone, Wujin District, Changzhou, Jiangsu, China

Mail: sales@qjmed.com

Web: www.qjmed.com



# Disposable Circular Staplers for Prolapse and Hemorrhoids (PPH) and Accessories



Circumferential resection accessories

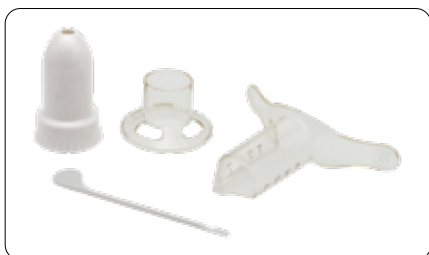

Elective resection accessories



# DISPOSABLE CIRCULAR STAPLERS FOR PROLAPSE AND HEMORRHOIDS (PPH) AND ACCESSORIES

## Application

It is suitable for resection to the prolapse of rectal mucosa in the anal canal or hemorrhoid mucosa, and restores the normal anatomic function of low rectum.

## Features and Advantages

- Smaller diameter could reduce the damage to tissue.
- Better stability and cutting strength with integrated annular cutter.



Wider viewport for precise examination.



High-quality imported titanium staples, stronger stitch tension.



Large cartridge housing capacity can hold more tissues.



Minimal anastomotic clearance to avoid tissue damage caused by excessive compression.

Specification	Staple Height (mm)	Staple Quantity (pcs)	Color
QYZ-32	3.8	32	Black
QYZ-34		34	White
QWZD-32		32	Black
QWZD-34		34	White

## Jiangsu Qianjing Medical Equipment Co.,Ltd

Add: No.6 Fengming Road, Wujin Hi-tech Industrial Development Zone, Wujin District, Changzhou, Jiangsu, China

Mail: sales@qjmed.com

Web: www.qjmed.com

# Disposable Circular Staplers



QIAN JING



# DISPOSABLE CIRCULAR STAPLERS

## Application

It is suitable for end-to-end anastomosis, end-to-side anastomosis and lateral anastomosis in digestive tract reconstruction such as esophagus, stomach and intestine.

## Features and Advantages

- Reduce post-operative hemorrhage with appropriate arrangement of staples.
- Super-thin anvil, more convenient for procedure.
- Adjustable thickness of tissue, meet all kinds of need.
- Streamline design is accordant with the human engineering, with as a comfortable powerful operation feel.



Integrally shaping anvil to ensure the shape of staples.



Minimum gap between anvil and cartridge to avoid the damage to tissue caused by over pressure.



Wider viewport for precise examination.



Large diameter ratio, avoids anastomotic stenosis effectively.



B-type staple with slightly incurved feet make the anastomotic a higher tensile strength.

Specification	Outside Diameter (mm)	Cutting Inner Diameter (mm)	Staple Quantity (pcs)	Anvil color
QYW-21	21.8	13.2	18	Dark Blue
QYW-23.5	24.3	15.2	18	Gold
QYW-25.5	26.2	17.2	20	Blue
QYW-28.5	29.2	20.2	24	Green
QYW-31.5	32	22.2	30	White
QYW-33.5	33.8	24.2	32	Grey

## Jiangsu Qianjing Medical Equipment Co.,Ltd

Add: No.6 Fengming Road, Wujin Hi-tech Industrial Development Zone, Wujin District, Changzhou, Jiangsu, China

Mail: sales@qjmed.com

Web: www.qjmed.com



# Disposable Linear Cutter Staplers and Reloads



QIAN JING

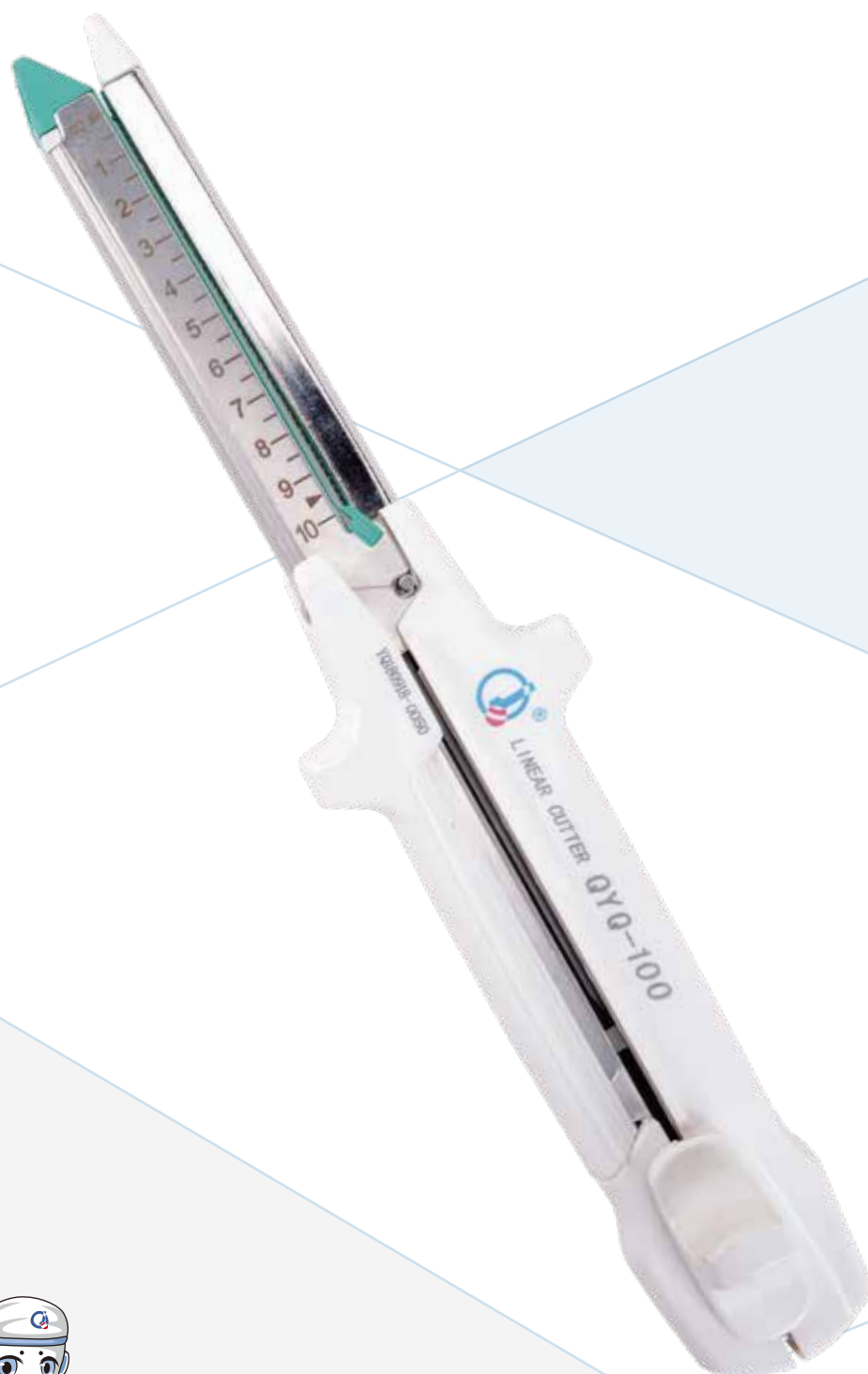

# DISPOSABLE LINEAR CUTTER STAPLERS AND RELOADS

## Application

It is applicable for transection, resection and the creation of anastomoses for digestive tissue and organ.



## Features and Advantages

- Double-row staples to reduce postoperative bleeding.
- One step forming anvil to ensure the staples formed completely.
- No less than 5 components can be replaced in the same operation.
- Interchangeable cartridge allows different tissue thickness.

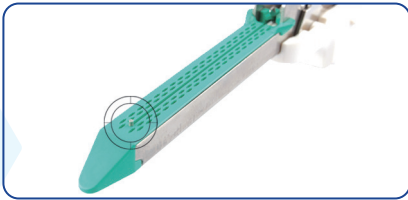

The tissue position pin makes staples in order.



Three different reloads available, accommodate a variety of tissue thickness.

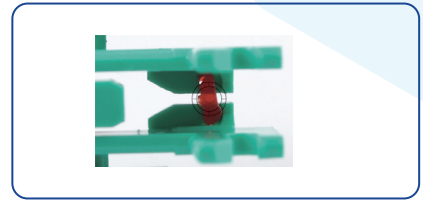

New safety device prevents empty staple cartridge from being mistakenly fired.

Specification	Cartridge specification	Suturing Length (mm)	Staple Quantity (pcs)	Staple Height (mm)	Cartridge Color
QYQ-55A	QD-55A	57	56	3.85	Blue
QYQ-55C	QD-55C			4.5	Green
QYQ-75A	QD-75A	77	76	3.85	Blue
QYQ-75C	QD-75C			4.5	Green
QYQ-100A	QD-100A	102	100	3.85	Blue
QYQ-100C	QD-100C			4.5	Green

### Jiangsu Qianjing Medical Equipment Co.,Ltd

Add: No.6 Fengming Road, Wujin Hi-tech Industrial Development Zone, Wujin District, Changzhou, Jiangsu, China

Mail: sales@qjmed.com

Web: www.qjmed.com

# Disposable Linear Cutter Staplers and Reloads

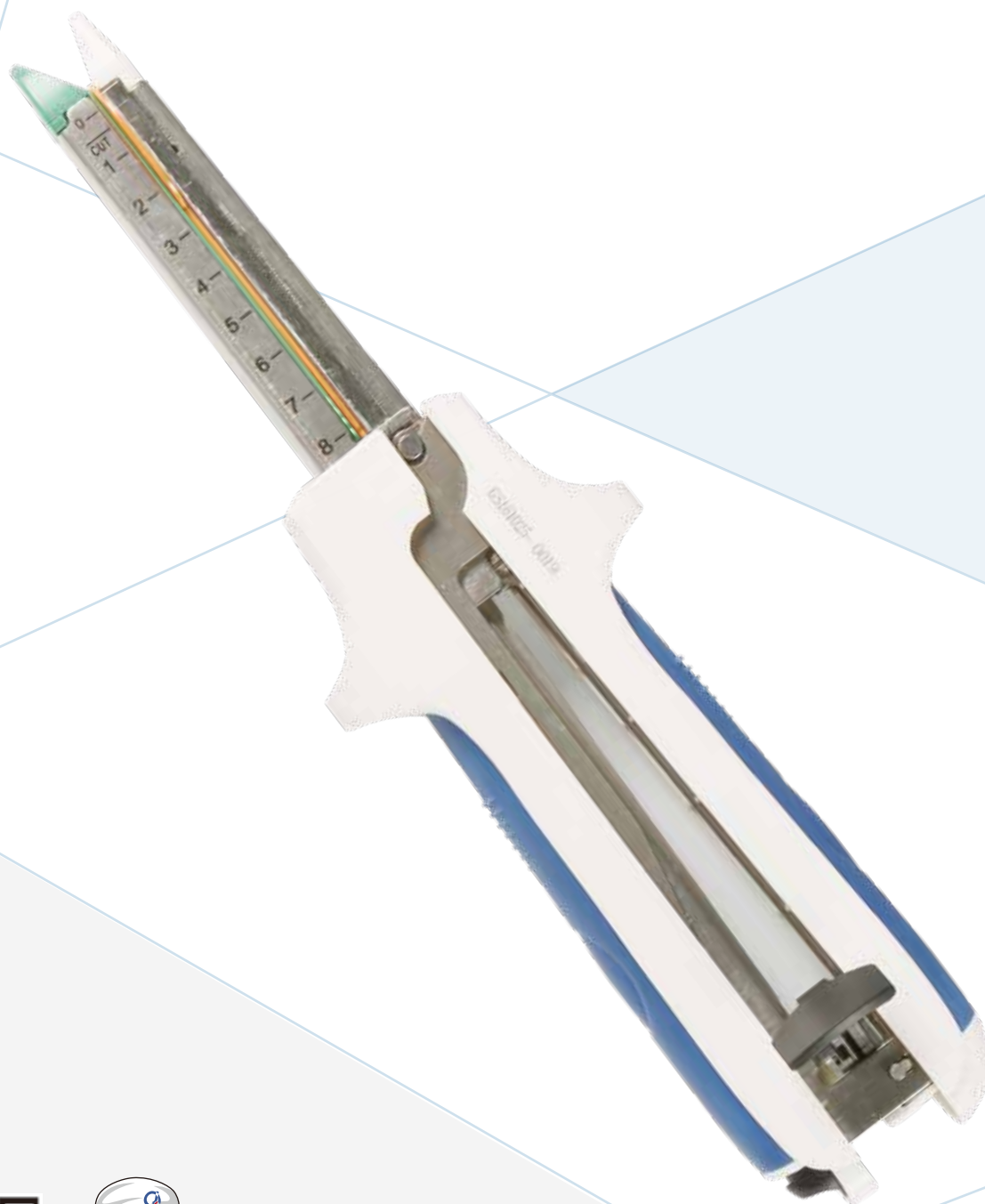

# DISPOSABLE LINEAR CUTTER STAPLERS AND RELOADS

## Application

For the creation of anastomosis and the closure of stumps or incisions in digestive tract reconstruction and other organ resection procedures.



## Features and Advantages

- Bilateral push button design, both left and right hands can be fired;
- Sewing first and then cutting, which is safer and more convenient;
- Two rows of staggered staples on both sides, better hemostasis effect, and maintain a good blood supply.
- Using high-quality imported titanium nails, with stronger suture tension.
- The cartridge is equipped with a cutting knife, and the cutting knife will also be replaced when the cartridge is replaced, which ensures the sharpness of the cutting knife.

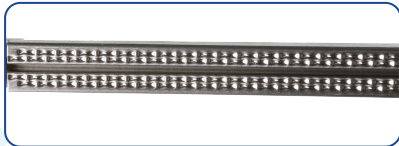

The design of the teardrop-shaped nail groove ensures the complete formation of the staples.

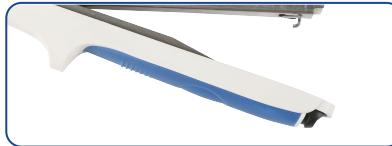

The non-slip handle design makes the firing feel more comfortable and safer to use.

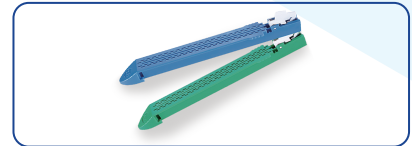

The cartridge is equipped with a cutting knife, and the cutting knife will also be replaced when the cartridge is replaced, which ensures the sharpness of the cutting knife.

Specification	Cartridge specification	Suturing Length (mm)	Staple Height (mm)	Staple Quantity (pcs)	Cartridge Color
QLGS-60A	QD-60SA	66	3.8	64	Blue
QLGS-80A	QD-80SA	86		84	
QLGS-60C	QD-60SC	66	4.5	64	Green
QLGS-80C	QD-80SC	86		84	

※ For more specifications and models, please refer to the product manual; technical parameters are subject to change without prior notice, please refer to the latest information; pictures are for reference only, please refer to the actual product.

## Applicable Departments

Thoracic Surgery, General Surgery, Gastrointestinal Surgery, Obstetrics and Gynecology, Urology, Hepatobiliary Surgery.

## Commonly Urgery

Cholecystectomy, megacolon surgery, gastroduodenal anastomosis, appendectomy, colon cancer radical surgery, etc.

### Jiangsu Qianjing Medical Equipment Co.,Ltd

Add: No.6 Fengming Road, Wujin Hi-tech Industrial Development Zone, Wujin District, Changzhou, Jiangsu, China

Mail: sales@qjmed.com

Web: www.qjmed.com



# Disposable Linear Staplers and Reloads



QIAN JING



# DISPOSABLE LINEAR STAPLERS AND RELOADS

## Application

It is used for the reconstruction of the digestive tract and the closure of the stump or the closure of the incision in the digestive tract reconstruction and organ resection.

## Features and Advantages

- Two segment close, convenient to adjust the tissue.
- Thickness of tissue sutured adjustable curing closing the instrument.
- Bigger opening distance, good for tissue arrangement.
- Clamp tissue automatically, easy for one-hand manipulation.

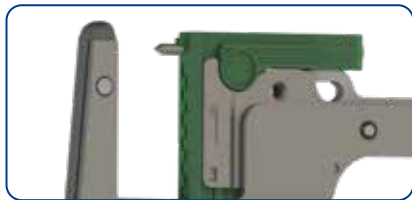

The position pin prevents overflow of tissues.



Different kinds of staple height for thin/thick tissue.

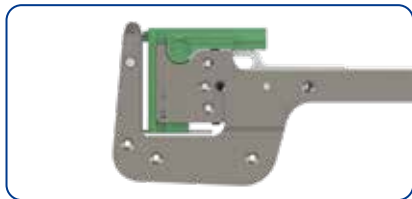

Minimal anastomosis gap to avoid tissue damage caused by excessive compression.

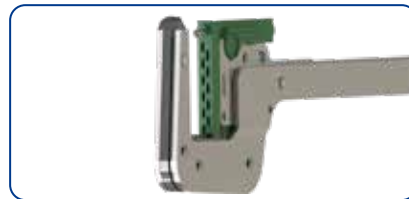

Slim anvil design for convenient organization and handling.

Specification	Cartridge specification	Suturing Length (mm)	Staple Quantity (pcs)	Staple Height (mm)	Cartridge Color
QYF-30H	QFD-30H	30	11	4.8	Green
QYF-30L	QFD-30L			3.8	Blue
QYF-45H	QFD-45H	45	15	4.8	Green
QYF-45L	QFD-45L			3.8	Blue
QYF-60H	QFD-60H	60	21	4.8	Green
QYF-60L	QFD-60L			3.8	Blue
QYF-90H	QFD-90H	90	33	4.8	Green
QYF-90L	QFD-90L			3.8	Blue

### Jiangsu Qianjing Medical Equipment Co.,Ltd

Add: No.6 Fengming Road, Wujin Hi-tech Industrial Development Zone, Wujin District, Changzhou, Jiangsu, China

Mail: sales@qjmed.com

Web: www.qjmed.com

# Disposable Curved Cutter Staplers and Reloads



QIAN JING



# DISPOSABLE CURVED CUTTER STAPLERS AND RELOADS

## Application

It is used for the reconstruction of the digestive tract and the closure of the stump or the closure of the incision in the digestive tract reconstruction and organ resection.

## Features and Advantages

- Two-stage closure for easy adjustment of the tissue to be closed.
- Four-row staples design for effective hemostasis.
- Good for the operation in the narrow space within the pelvic, thus ensuring the operation effect.
- Simultaneous cutting and suture simplification of low rectal operation.
- Tissue pin design to prevent tissue overflow.



Tissue positioning needle is designed to prevent tissue split and promise safety.



Unique curved shape for wide laparoscopic view of the lower rectum in the deep pelvis.

Specification	Cutting Length	Suturing Length (mm)	Staple Quantity (pcs)
QYH-A45	40	45	46
QLB-HA35	20	24	21

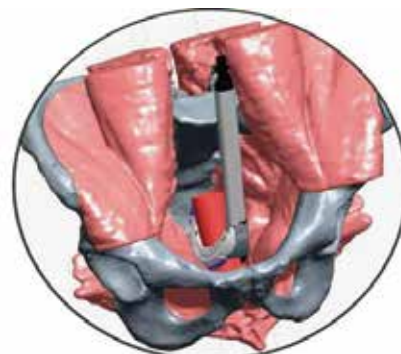

**Jiangsu Qianjing Medical Equipment Co.,Ltd**

Add: No.6 Fengming Road, Wujin Hi-tech Industrial Development Zone, Wujin District, Changzhou, Jiangsu, China

Mail: sales@qjmed.com

Web: www.qjmed.com



# Disposable Skin Staplers and Removers

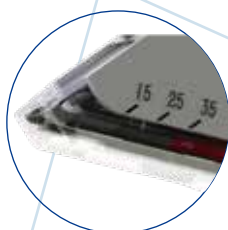

Transparent staple cartridge for observing staples



Staple remover

## Application

Applied to skin suture for all kinds of trauma and surgical incision.

## Features and Advantages

- Better apposition of skin edges with better cosmetic results.
- Significantly decrease wound closure time and reduce surgery&anesthesia time.
- Sterilized by radiation and decrease the chance of infection.
- Come with an angled tip for a clear view, are light weight.

Specification	Staple Height (mm)	Staple Quantity (pcs)
QPW-15N	5.4*3.6	15
QPW-15W	7.0*4.0	15
QPW-25N	5.4*3.6	25
QPW-25W	7.0*4.0	25
QPW-35N	5.4*3.6	35
QPW-35W	7.0*4.0	35
QPW-45N	5.4*3.6	45
QPW-45W	7.0*4.0	45



**Jiangsu Qianjing Medical Equipment Co.,Ltd**

Add: No.6 Fengming Road, Wujin Hi-tech Industrial Development Zone, Wujin District, Changzhou, Jiangsu, China

Mail: sales@qjmed.com

Web: www.qjmed.com

# Disposable Circumcision Stapler



QIAN JING



# DISPOSABLE CIRCUMCISION STAPLER

## Application

It is suitable for clinical circumcision and suture.

## Features and Advantages

- It can be fast hemostasis and easy removable staples with the silicone ring.
- Quick threaded design reduces the number of turns and shortens the operation time.
- Increased staple density for bleeding-free surgery
- Outpatient surgery usually does not require a second return to the hospital. Do not affect the amount of activity and normal work and study after surgery, you can take a shower after one week.

Specification	Cutting Diameter (mm)	Staple Height (mm)	Staple Quantity (pcs)
QBSA4-11×2.8	11	2.8	9
QBSA4-13×2.8	13		10
QBSA4-15×2.8	15		11
QBSA4-17×2.8	16.5		12
QBSA4-19×2.8	18		13
QBSA4-22×2.8	22		16
QBSA4-25×2.8	25		18
QBSA4-29×2.8	29		20
QBSA4-32×2.8	32		22
QBSA4-34×2.8	34		24



Unique staple design, penetrates tissue well and good hemostatic effect, the staples are easy to fall off.



Pure metal integrated anvil, offer more stability during surgery, to avoid the plastic anvil easy to break, suture gap extension and other undesirable phenomena.

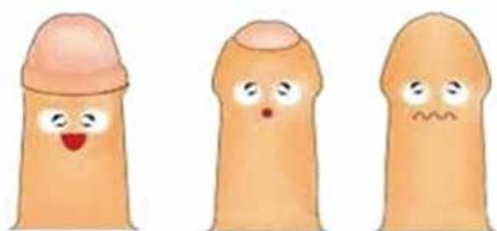

Normal foreskin    Foreskin is too long    Foreskin phimosis

## Jiangsu Qianjing Medical Equipment Co.,Ltd

Add: No.6 Fengming Road, Wujin Hi-tech Industrial Development Zone, Wujin District, Changzhou, Jiangsu, China

Mail: sales@qjmed.com

Web: www.qjmed.com

# Disposable Trocars



QIAN JING

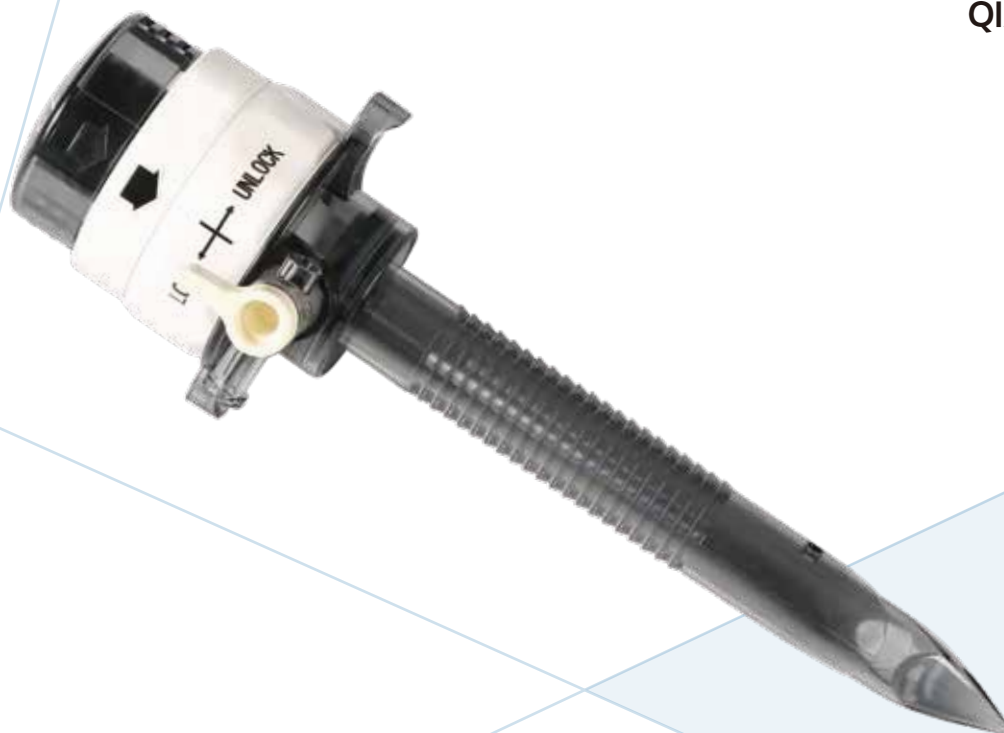

## Application

It is used for laparoscopy surgery, the puncture of the abdominal wall of the human body is used to establish a working channel for abdominal surgery.

## Features and Advantages

- Unique air-tight design to prevent gas leakage.
- Anti-slip grain design, increasing the friction between cannular and abdominal wall, to avoid cannular fall off.
- Universal positioning of puncture cone without directional insertion.

Model	Trocar cannula inner diameter (mm)	Cannula length (mm)	Obturator outer diameter (mm)
QYC-5/100	5.9	96	5.8
QYC-10/100	10.5	97	10.4
QYC-12/100	12.9	98	12.8
QYC-15/100	15.8	111	15.7



**Jiangsu Qianjing Medical Equipment Co.,Ltd**

Add: No.6 Fengming Road, Wujin Hi-tech Industrial Development Zone, Wujin District,  
Changzhou, Jiangsu, China

Mail: [sales@qjmed.com](mailto:sales@qjmed.com)

Web: [www.qjmed.com](http://www.qjmed.com)



# Disposable Incision Retractor Fixator



QIAN JING



## Application

It is suitable for small incision surgery, minimally invasive surgery and incision expansion to prevent incision injury and reduce incision infection.

## Features and Advantages

- Effective reduction of surgical incision size, greater degree of retract wound, and make surgical vision fully exposed.
- Easy to operate, avoid bleeding during surgery.
- Full range of sizes for different procedures' requirements.
- Disposable use to avoid cross-infection.

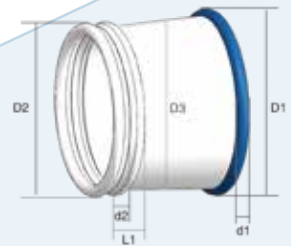

unit(mm)

Specification	Size	D1	D2	D3	L	Tolerance	d1	d2	L3
QYK-I	60/70-60/150	70	60	60	150	±8.0	6	6	12
	80/90-80/150	90	80	80	150	±8.0	6	6	12
	120/130-120/250	130	120	120	250	±10.0	6	6	12
	150/160-150-250	160	150	150	250	±10.0	6	6	12
	180/190-180/250	190	180	180	250	±10.0	6	6	12
	220/230-220/250	230	220	220	250	±10.0	6	6	12
	270/280-270/250	280	270	270	250	±15.0	7	7	15
	320/330-320/250	330	320	320	250	±15.0	7	7	15
QYK-II	40/30-15/20	40	30	15	20	±5.0	3.5	3.5	—
	50/40-25/25	50	40	25	25	±5.0	3.5	3.5	—
	70/70-35/40	70	70	35	40	±5.0	4	4	—



**Jiangsu Qianjing Medical Equipment Co.,Ltd**

Add: No.6 Fengming Road, Wujin Hi-tech Industrial Development Zone, Wujin District,  
Changzhou, Jiangsu, China

Mail: sales@qjmed.com

Web: www.qjmed.com

## GEN100 Ultrasonic Scalpel System Product Configuration

Component	Model	Description	Package
Generator	GEN100	Power cord included	1 set/box
Scalpel	MPS275	Length 23cm, gun style	1 piece/carton
	MPS404	Length 36cm, gun style	1 piece/carton
Energy exchange system	Trans56100	Test rod included	1 piece/carton
Foot switch	FS100	Matching generator use	1 piece/carton

## MPS Ultrasonic Scalpel Knife

Name	Model	Description	Package
Ultrasonic Scalpel Knife	MPS140A MPS230A MPS360A	Length 14 cm, gun type Length 23 cm, gun type Length 36 cm, gun type	1 piece/box
	MPS140B MPS230B MPS360B	Length 14 cm, gun type Length 23 cm, gun type Length 36 cm, gun type	
	MPS140C MPS230C MPS360C	Length 14 cm, gun type Length 23 cm, gun type Length 36 cm, gun type	



### Jiangsu Qianjing Medical Equipment Co.,Ltd

Telephone: 0086-519-86226176

Mobile Phone: +8613812226033

Email: sales@qjmed.com

Website: www.qjmed.com

Address: No.6 Fengming Road, Wujin Hi-tech Industrial Development Zone, Wujin District, Changzhou, Jiangsu, China

## GEN100 Ultrasonic Scalpel System

## MPS Ultrasonic Scalpel Knife



Focus on the field  
of surgical instruments  
Committed to all-in-one  
solutions for minimally invasive surgery

# GEN100 Ultrasonic Scalpel System

- Generator
- Transduction system
- cutter
- foot switch

## Features:

### Cost-effective

- ◆ The energy conversion system has a long service life and the greatest application value.
- ◆ Integrated torque wrench helps with inventory control.
- ◆ Energy conversion system and scalpels can be separated, thereby reducing replacement costs.

### Efficient

- ◆ One device for multiple purposes: cutting to stop bleeding, grasping and separating.
- ◆ 56 ± 1KHz working frequency, cutting and hemostasis are completed simultaneously, shortening the operation time.

### Safety

- ◆ Low lateral heat loss, can be used for vital organs.
- ◆ Electric energy is converted into mechanical energy to work, no current passes through the human body, and the patient is safer.
- ◆ The curved working head is good for observing the tissue clamped by the jaws.
- ◆ Smoke-free, providing clear surgical vision.



**Generator**  
Model: GEN100

The generator provides electrical energy for the energy conversion system and drives the tool to mechanically oscillate at a frequency of 56 ± 1KHz. The generator output is divided into five gears, and the output energy gradually increases from the first gear to the fifth gear. The higher the gear, the better the cutting effect, and the lower the gear, the better the coagulation effect.



**Foot switch**  
Model: FS100

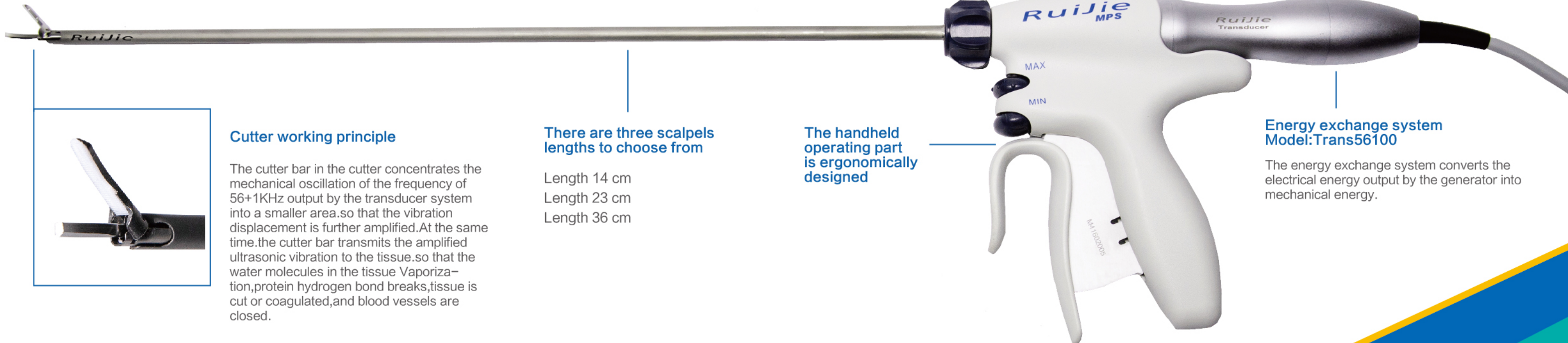

### Cutter working principle

The cutter bar in the cutter concentrates the mechanical oscillation of the frequency of 56+1KHz output by the transducer system into a smaller area, so that the vibration displacement is further amplified. At the same time, the cutter bar transmits the amplified ultrasonic vibration to the tissue, so that the water molecules in the tissue vaporize, protein hydrogen bond breaks, tissue is cut or coagulated, and blood vessels are closed.

### There are three scalpels lengths to choose from

- Length 14 cm
- Length 23 cm
- Length 36 cm

### The handheld operating part is ergonomically designed

### Energy exchange system

Model: Trans56100

The energy exchange system converts the electrical energy output by the generator into mechanical energy.



## Scope of Application

Vessel Sealing and Cutting System Can be used to close and cut vessels and tissue up to 7 mm. Vessel sealing and cutting system instruments can be matched with high-frequency vascular closure system, high-frequency electrosurgical knife, energy platform, and other high-frequency generators for electrocoagulation, hemostasis, and cutting during surgery.

## Specifications

Product name	Vessel sealing and cutting system
Specification	SM5000
Rated output power	Bip Coag 180W/100Ω Bip Cut 100W/300Ω
Working condition	Temperature:10℃~40℃; Humidity:30%~75%
Atmospheric pressure	700hPa~1060hPa
Power supply	220V/110V ±22V; 50Hz±1Hz
Weight	14Kg
Unit Dimension	480mm (L) ×400mm (W) ×140mm (H)
Package Dimension	550mm (L) ×550mm (W) ×340mm (H)

Instruments specifications	Closed length (mm)	Cutting length (mm)	Insertion part outer diameter (mm)	Effective length (mm)	Electrode cable length (mm)	Jaw Type
SM1100	21	19	10	370	2800	Straight tip
SM1200	21	19	10	200	2800	Straight tip
SM1500	18	16	5	370	2800	Straight tip
SM1500W	22	20	5	370	2800	Curve tip
SM1520	18	16	5	200	2800	Straight tip
SM1520W	22	20	5	200	2800	Curve tip
SM1544	18	16	5	440	2800	Straight tip
SM1544W	22	20	5	440	2800	Curve tip
SM2150	21	19	/		2800	Curve tip

※ For more specifications and models, please refer to the product manual; technical parameters are subject to change without prior notice, please refer to the latest information; pictures are for reference only, please refer to the actual product.

## Surgery of Application

### Suitable for open and laparoscopic surgery

Thoracic Surgery: Lobectomy, Esophagectomy.

Bariatric Surgery: Sleeve Gastrectomy, Gastric Bypass.

Gastrointestinal: Gastrectomy anus/colon, appendectomy.

Obstetrics and Gynecology: Hysterectomy, Ovariosalpingectomy.

Urology: Prostatectomy, Cystectomy, Nephrectomy, Andre.

Hepatobiliary and Pancreatic Surgery: Hepatectomy, Splenectomy, Cholecystectomy, Pancreaticoduodenectomy.etc.



**Jiangsu Qianjing Medical Equipment Co.,Ltd**

Add: No.6 Fengming Road, Wujin Hi-tech Industrial Development Zone,  
Wujin District, Changzhou, Jiangsu, China

Mail: sales@qjmed.com

Web: www.qjmed.com



QIAN JING

# Vessel Sealing and Cutting System

SM5000

Vessel Sealing and Cutting System Generator

SM series

Vessel Sealing and Cutting System Instruments



Focus on  
**Surgical Instruments**  
Provide Total Surgical Solutions



# Vessel Sealing and Cutting System

# Vessel Sealing and Cutting System Generator



## Excellent sealing performance Safer and more efficient

- Closure of vessels/tissue bundles up to 7mm in diameter.
- The closure band can withstand three times the pressure of normal systolic blood (over 360mmHg).
- The closing speed is fast, no smoke is generated, and the vision is clear.
- Minimum thermal damage, transverse thermal damage <2mm.
- There is no foreign body residue in the operation, reducing adhesion and carbonization.
- Reduce surgical blood loss, shorten operation time, and reduce patient hospital stay.



- Organize real-time detection technology and intelligent power control technology.
- Stable temperature control to reduce thermal damage.
- Constant pressure control to ensure consistent closing effect.

- Tissue density real-time feedback technology, real-time identification of tissue types,
- The intelligent host adjusts and outputs appropriate power according to different tissue types to ensure a consistent closure effect.
- Minimal voltage output, control the generation of sparks. Reduce tissue damage.



### Pliers

- Straight tip, Curve tip optional
- Blunt tip to avoid tissue damage
- Textured surface for improved tissue grip

### Pliers rod

Multiple size configuration, multiple choices

### Rotation wheel

Rotating shaft design, the angle is arbitrary

### Start up button

Triggered

### Cutting trigger

Smooth knife out, independent cutting and rebound, easy operation

### Closed handle

Automatic locking and pressure keeping, safe and reliable

### Sandle





# Disposable Power Endoscopic Linear Cutter Staplers and Reloads



Instrument Model			Front Straight Rod Length ( mm )
QEA45S	QEB45S	QEC45S	197
QEA60S	QEB60S	QEC60S	
QEA45M	QEB45M	QEC45M	257
QEA60M	QEB60M	QEC60M	
QEA45L	QEB45L	QEC45L	359
QEA60L	QEB60L	QEC60L	

Model Specifications		Suture Length	Nail Height (mm)	Colour
EFA45M	EFB45M	49	2.0	Grey
EFA45W	EFB45W		2.5	White
EFA45B	EFB45B		3.5	Blue
EFA45D	EFB45D		3.8	Gold
EFA45G	EFB45G		4.1	Green
EFA45T	EFB45T		4.3	Black
EFA60M	EFB60M		61	2.0
EFA60W	EFB60W	2.5		White
EFA60B	EFB60B	3.5		Blue
EFA60D	EFB60D	3.8		Gold
EFA60G	EFB60G	4.1		Green
EFA60T	EFB60T	4.3		Black



※ For more specifications and models, please refer to the product manual; technical parameters are subject to change without prior notice, please refer to the latest information; pictures are for reference only, please refer to the actual product.

**Jiangsu Qianjing Medical Equipment Co.,Ltd**  
 Add: No.6 Fengming Road, Wujin Hi-tech Industrial Development Zone, Wujin District, Changzhou, Jiangsu, China  
 Mail: sales@qjmed.com  
 Web: www.qjmed.com





# DISPOSABLE POWER ENDOSCOPIC LINEAR CUTTER STAPLERS AND RELOADS

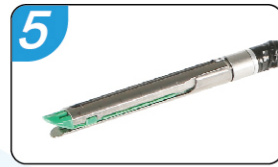

5 The jaws have a suitable pre-support force, which is not only conducive to pressing the tissue, but also prevents tissue damage caused by excessive pressing.



6 The high-hardness alloy cutter is quenched, extremely sharp, and the cutting structure is more complete.

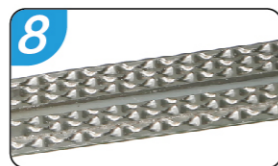
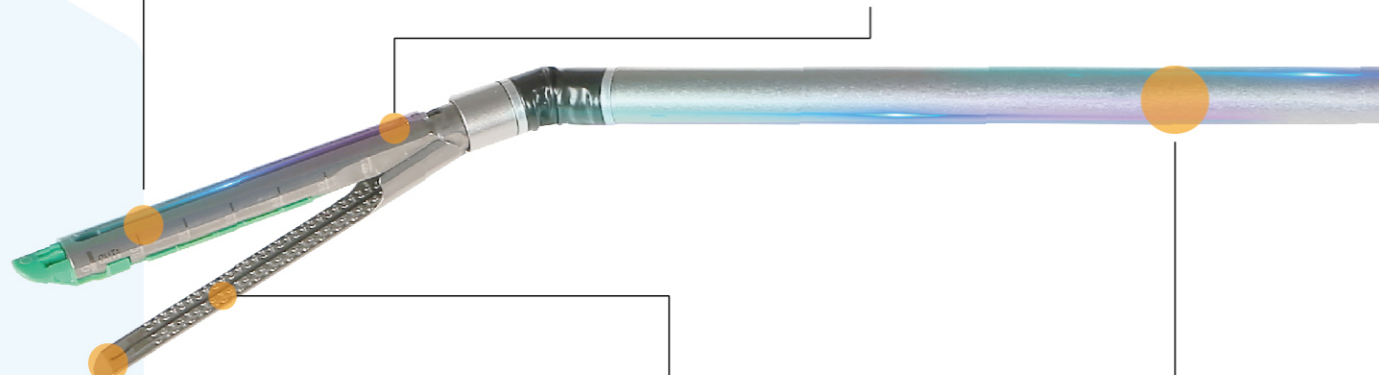

8 The "drop-shaped" nail groove design ensures the effective effect of the B-shape of the staples and improves the clinical suture forming effect.

1

Standard, lengthened and shortened length specifications are available to meet different clinical surgical needs.

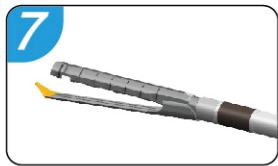

7 The style of the hook mouth anvil seat is optional, which is specially designed for the cutting and suture of tubular tissue.

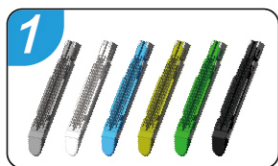
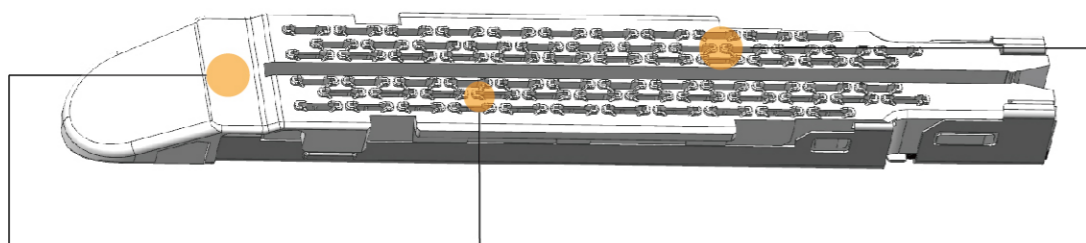

1 Grey, white, blue, gold, green and black are available in six height specifications, suitable for tissues of different thicknesses.

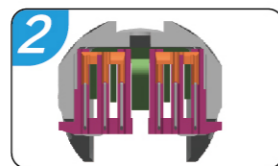

2 The design of three staggered rows of sutures on the left and right anvils avoids bleeding on the surgical surface; the equal-height sutures are evenly anastomosed to reduce tissue damage.

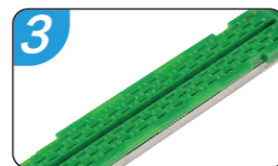

3 The non-slip design of the imitation gecko claws on the surface of the nail bin enhances the grip on the tissue and ensures the precision and safety of the cutting seam. (Anti-gecko claw non-slip surface and smooth surface are optional)



2 The 360° rotating adjustment knob is matched with the left and right 45° swing knob, which can reach the target part more conveniently and accurately.

3

Electric and manual double emergency return to ensure the safety of surgery.

firing wrench

safety switch

closed handle



4 Electric drive, smooth firing and smooth cutting, ensure the effect of staple forming and avoid bleeding during surgery.

## Application

It is suitable for the dissection, resection and/or establishment of staplers of organs and tissues in the body. Suitable for a variety of open or minimally invasive surgeries.

## Applicable departments

General surgery, thoracic surgery, obstetrics and gynecology, hepatobiliary surgery, pediatric surgery, urology.

## Common surgeries

Laparoscopic sleeve gastrectomy, laparoscopic radical gastrectomy, partial lobectomy, low anterior proctectomy, laparoscopic left/right hemicolectomy, etc.